

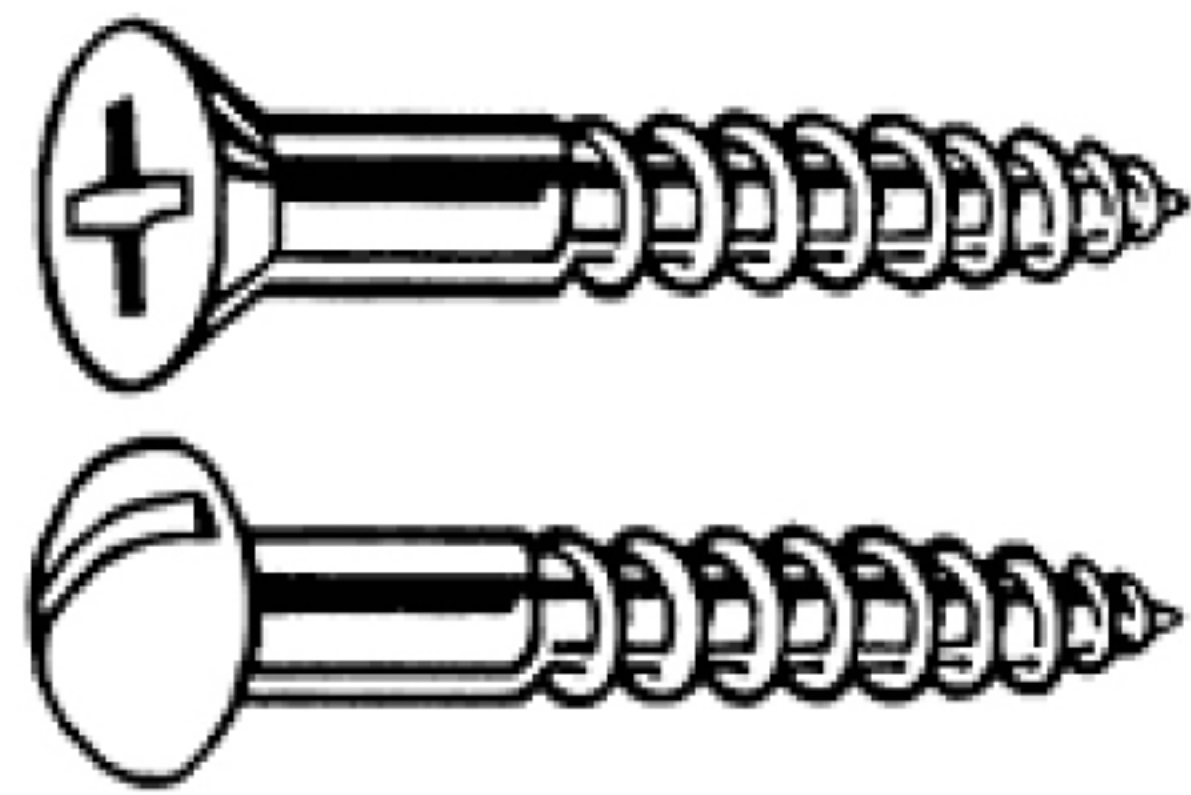

FASTENER TYPE CHART

Fastener Categories



Wood Screws

Screws with a smooth shank and tapered point for use in wood. Abbreviated WS

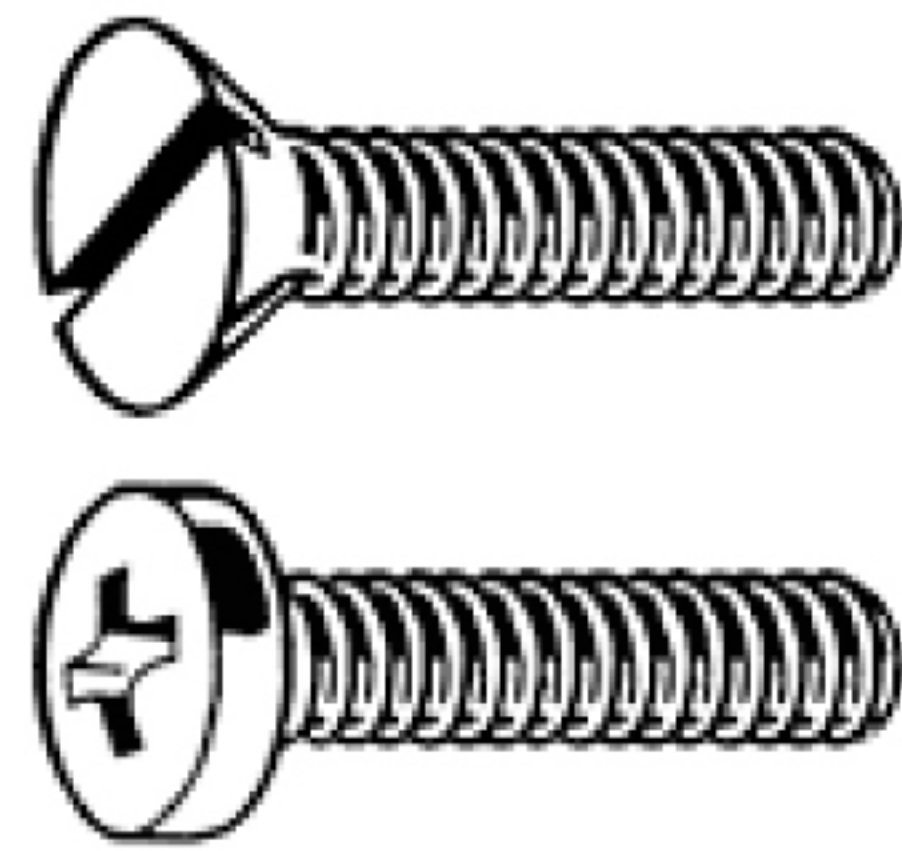

Machine Screws

Screws with threads for use with a nut or tapped hole. Abbreviated MS

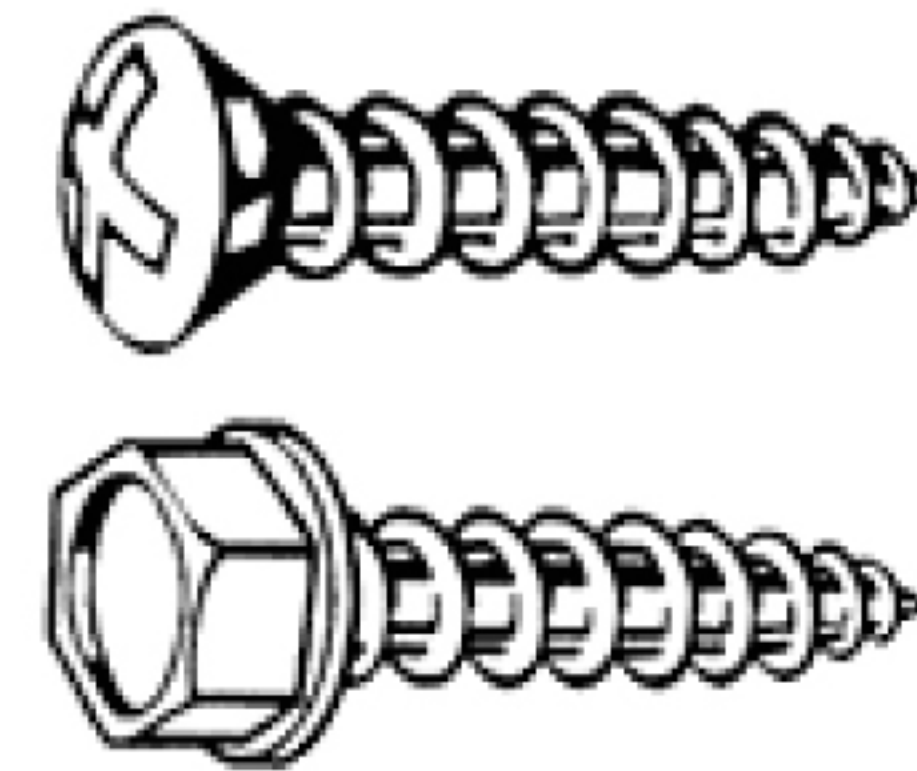

Sheet Metal Screws

Fully threaded screws with a point for use in sheet metal. Abbreviated SMS



Self Drilling SMS

A sheet metal screw with a self drilling point.

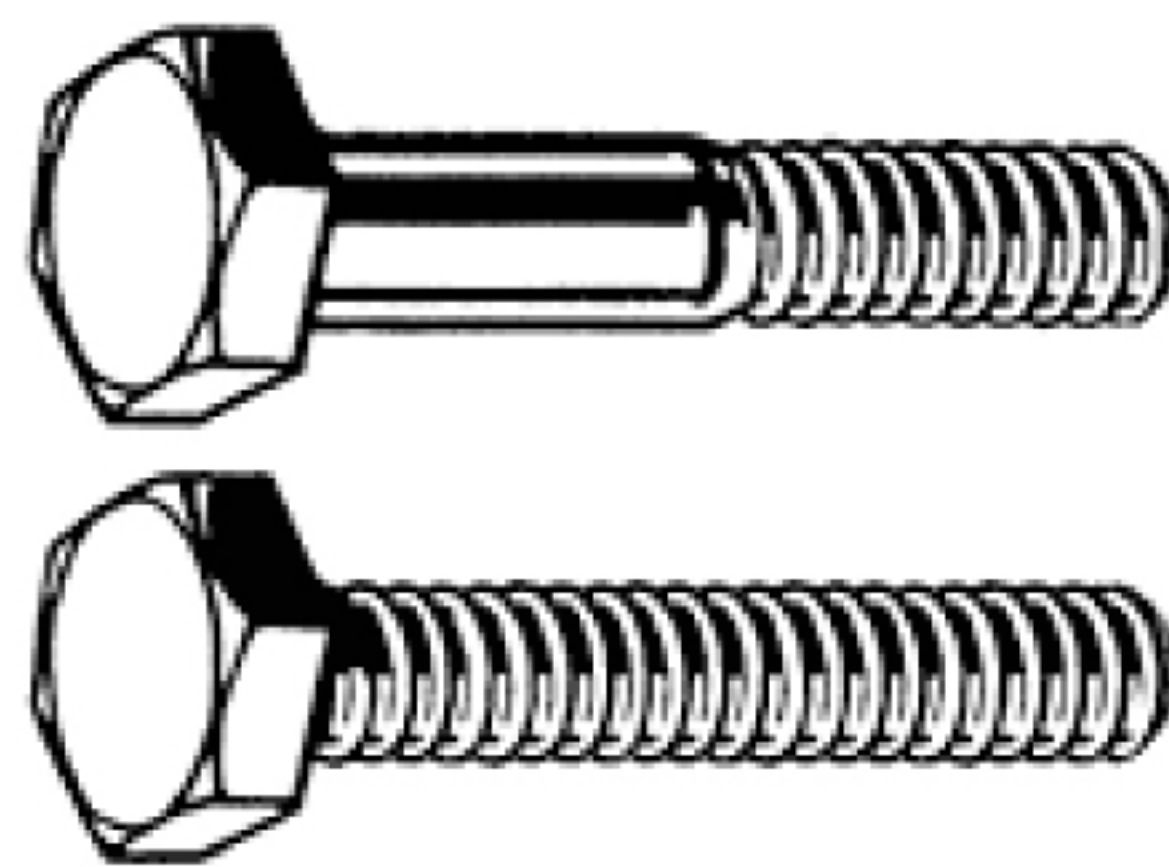

Hex Bolts

Bolts with a hexagonal head with threads for use with a nut or tapped hole. Abbreviated HHMB or HXBT.

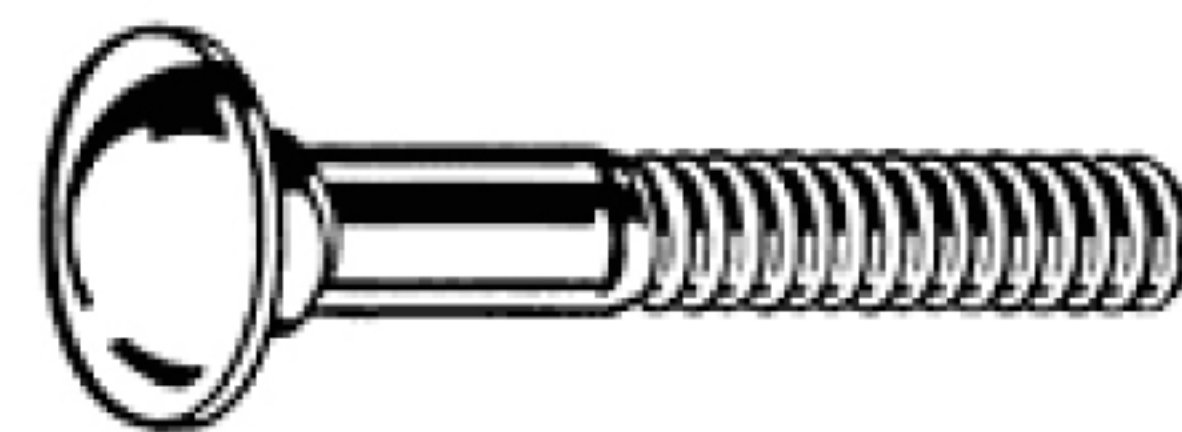

Carriage Bolts

Bolts with a smooth rounded head that has a small square section underneath.



Lag Bolts

Bolts with a wood thread and pointed tip. Abbreviated Lag.



Set Screws

Machine screws with no head for screwing all the way into threaded holes.

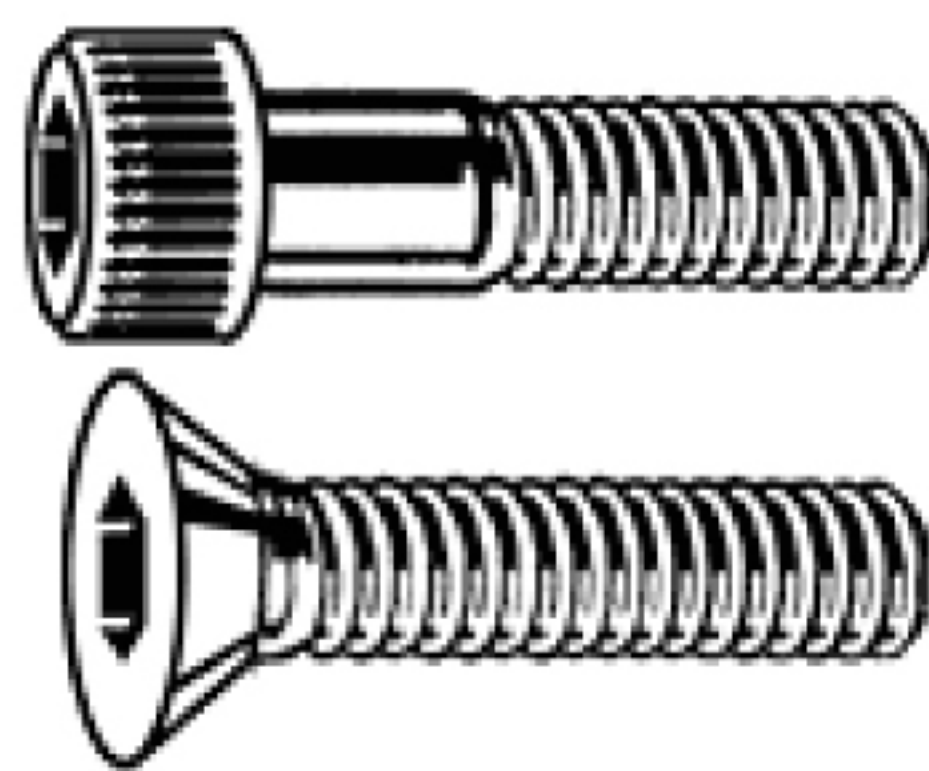

Socket Screws

Socket screws, also known as Allen Head, are fastened with a hex Allen wrench.



Eye Bolts

A bolt with a circular ring on the head end. Used for attaching a rope or chain.



Eye Lags

Similar to an eye bolt but with wood threads instead of machine thread.

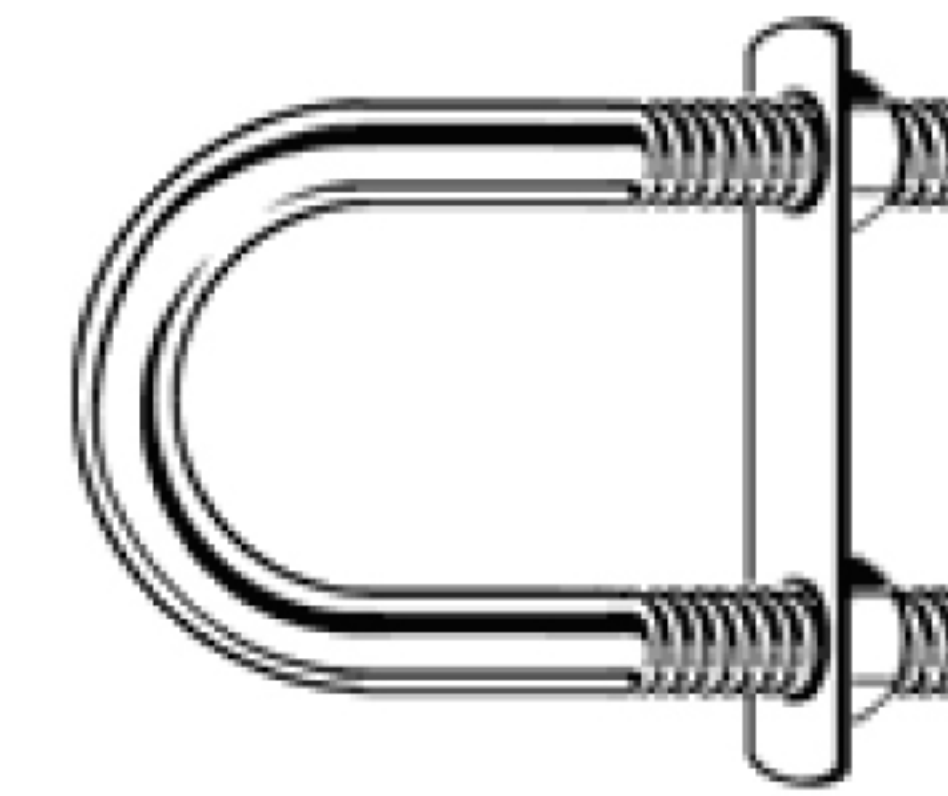

U-Bolts

Bolts in U shape for attaching to pipe or other round surfaces. Also available with a square bend.



J-Bolts

J shaped bolts are used for tie-downs or as an open eye bolt.



Hanger Bolts

Hanger bolts have wood thread on one end and machine thread on the other end